

96.513

Addit Fußstütze - verstellbar 513

Fußstützen unterstützen die Beine und entlasten damit indirekt den Lendenwirbelbereich, was aufrechtes Sitzen erleichtert. Diese praktische Fußstütze ist verstellbar in Höhe und Winkel und hat vier verschiedene Einstellungen.

- Attraktives Design
- 4 verschiedene Einstellungen für Höhe und Winkel
- Höhenverstellbar 79 - 111 mm
- Abmessungen (B x T x H): 450 x 348 - 371 x 79 - 111 mm
- Winkeleinstellung in 3 Schritten: 6°, 12°, 16° und 25°

addit

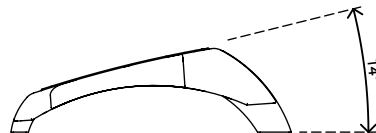
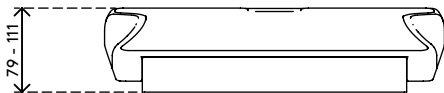
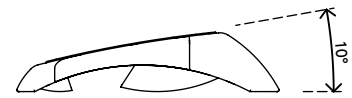
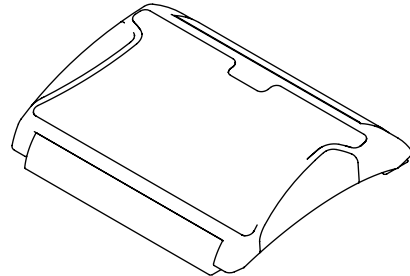
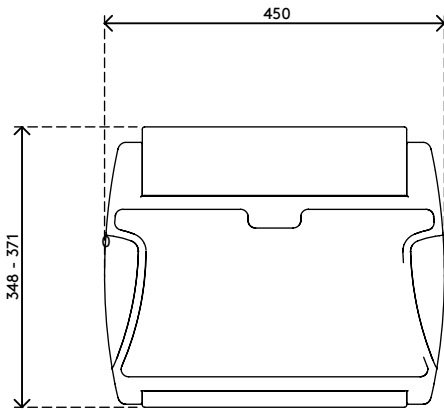

Addit Fußstütze - verstellbar 513

2016/11/23

96.513

 405 x 350 x 90 mm

 1 pcs

 schwarz

 1,66 kg

 805410965136